

Specifications/技术参数:

Electrical/电气特性:

Current Rating(额定电流): 1A
 Withstand Voltage(耐压值): 500VAC for one minute
 Contact Resistance(接触电阻): 20mΩ max
 Insulation Resistance(绝缘电阻): 1000MΩ min
 Operating Temperature(工作温度): -40°C ~ +105°C

Physical/物理特性:

Insulator(塑胶本体): P.B.T or PA6T +30%GF, Color Black
 Flammability Rating(防火等级): UL 94V-0
 Contacts(接触件): Phosphor Bronze
 Contacts plating(接触件电镀): Gold flash over Nickel

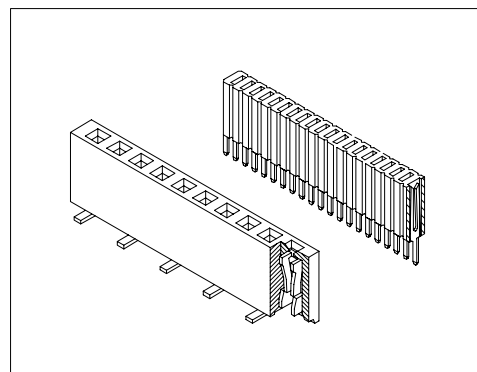

Dimension/尺寸: mm

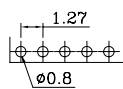
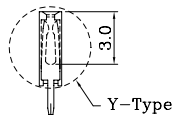
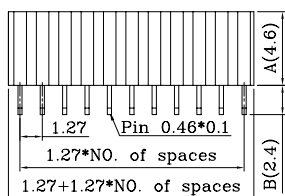

PCB LAYOUT
线路板布局图

1.27mm Female header/排母
 Single row 06 to 40 contacts/单排6-40芯
 Profile/塑高: 4.6mm
 Pin length/焊板针长: 2.4mm
 Ordering Code/订购型号:
 203-1S-Y-1*nPG-4.6/2.4

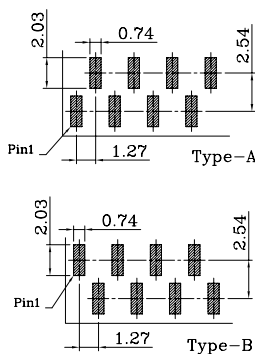
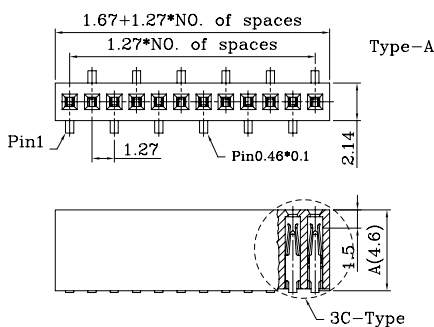

PCB LAYOUT
线路板布局图

1.27mm SMT Female header/贴片排母
 Single row 03 to 50 contacts/单排3-50芯
 Profile/塑高: 4.6mm
 Ordering Code/订购型号:
 203-1SMS-3C-1*nPG-4.6-A

Ordering Code/订购型号:

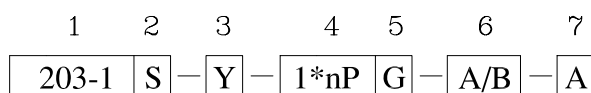

1. Series No./系列号: 203-1

2. PCB Mount Type/安装类型:

S = Vertical DIP Type(直插)
 SMS = Vertical SMT Type(立贴)

3. Contacts Type/接触件类型:

Y = Y-Type(二面包)
 3C = 3C-Type(三面包)

4. Poles/位数:

Single/单排: 1*4P ~ 1*40P

5. Contacts plating/接触件电镀:

S = Selective Gold(半金)
 G = Gold flash(全金)

6. Dimension/尺寸: A/B

7. Options/选项:

A = Type-A (正脚位)
 B = Type-B (反脚位)