

Specifications/技术参数:

Electrical/电气特性:
 Current Rating (额定电流): 1A
 Withstand Voltage (耐压值): 500VAC for one minute
 Contact Resistance (接触电阻): 20mΩ max
 Insulation Resistance (绝缘电阻): 1000MΩ min
 Operating Temperature (工作温度): -40°C ~ +105°C

Physical/物理特性:
 Insulator (塑胶本体): P.B.T +30% Glass Fiber
 Flammability Rating (防火等级): UL 94V-0
 Contacts (接触件): Phosphor Bronze or Brass
 Contacts plating (接触件电镀): Gold over Nickel or Tin

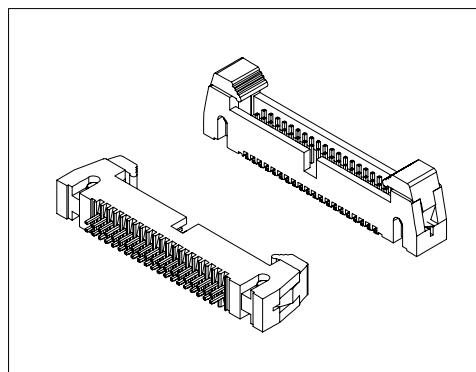

Dimension/尺寸: mm

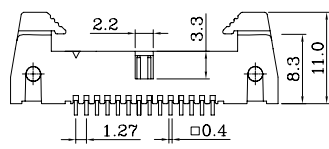
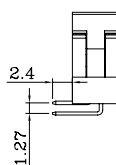
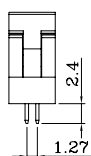
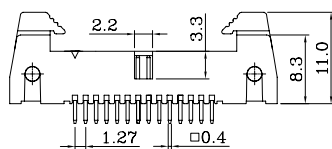
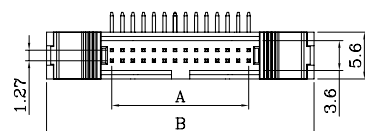
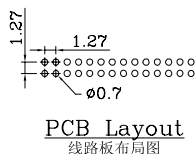
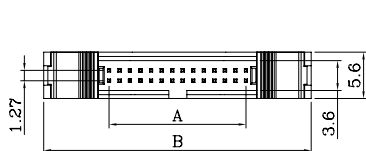

Straight/直插

Right Angle/弯插

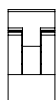
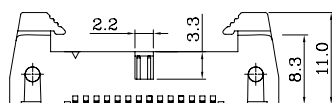
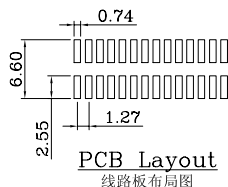
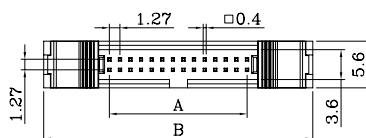

SMD Type/立贴

Poles	Dim A	Dim B
10	5.08	20.85
14	7.62	23.39
16	8.89	24.66
20	11.43	27.20
24	13.97	29.74
26	15.24	31.01
30	17.78	33.55
34	20.32	36.09
40	24.13	39.90
44	26.67	42.44
50	30.48	46.25
60	36.83	52.60

Ordering Code/订购型号:

1 2 3 4 5
301-1/B - S - 20P S - 4

1. Series No./系列号: 301-1/B
2. PCB Mount Type/安装类型:
 S = Straight DIP Type(直插)
 R = Right Angle DIP Type(弯插)
 SMS = SMD Type(立贴)
3. Poles/位数: 10~60P

4. Contacts plating/接触件电镀:
 N/A(缺省) = Gold Flash(全金)
 S = Selective Gold(半金)
5. Color/胶体颜色:
 N/A(缺省) = Black(黑色)
 4 = Grey(灰色)