

## Ordering Code/订购型号:

1      2      3  
 [DH] — [09P] — [H4]

1. Series No./系列号:

DH

2. Poles/位数:

09P、15P、25P、37P

3. Insulator color/胶体颜色:

H3 = Black(黑色)

H4 = Grey(灰色)

CR = Metalized(金属银)

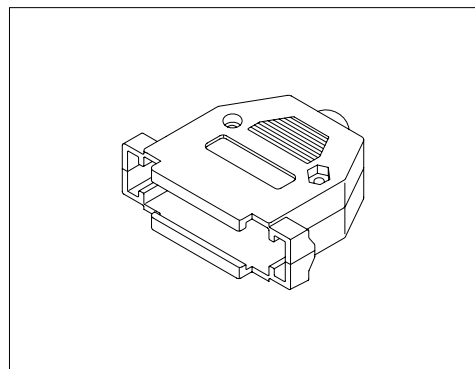

## Dimension/尺寸: mm

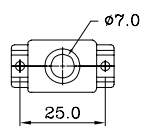
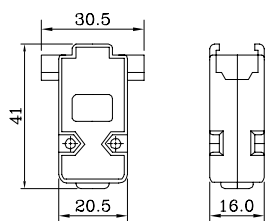

DH-09P-H4

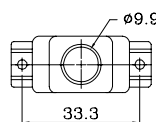
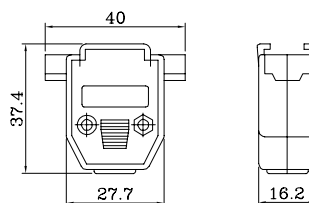
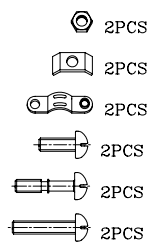

DH-15P-H4

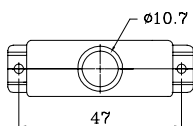
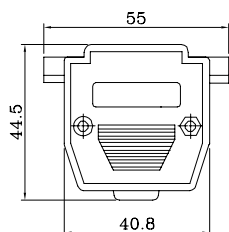
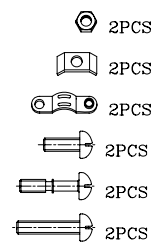

DH-25P-H4

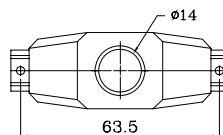
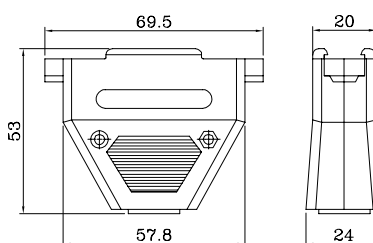
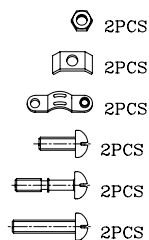

DH-37P-H4

