

Specifications/技术参数:

Electrical/电气特性:

Current Rating (额定电流): 1A
 Withstand Voltage (耐压值): 1000VAC for one minute
 Contact Resistance (接触电阻): 20mΩ max
 Insulation Resistance (绝缘电阻): 1000MΩ min
 Operating Temperature (工作温度): -40°C ~ +105°C

Physical/物理特性:

Insulator (塑胶本体): Glass filled Polyester, Black
 Flammability Rating (防火等级): UL 94V-0
 Contacts (接触件): Phosphor Bronze
 Contacts plating (接触件电镀): Tin

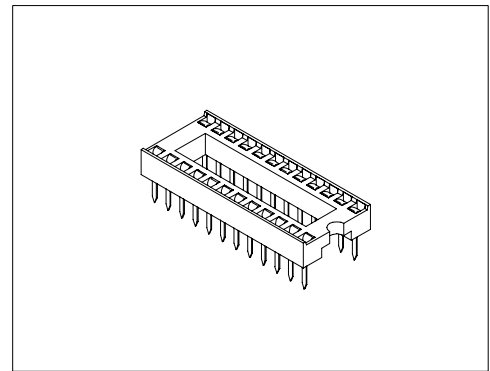

Dimension/尺寸: mm

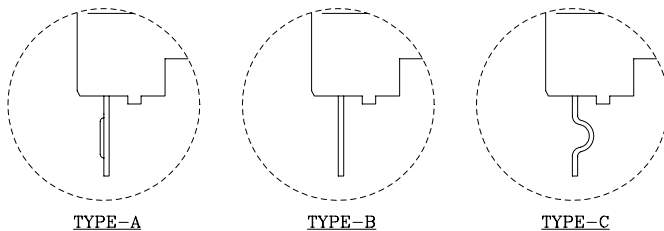
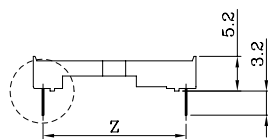
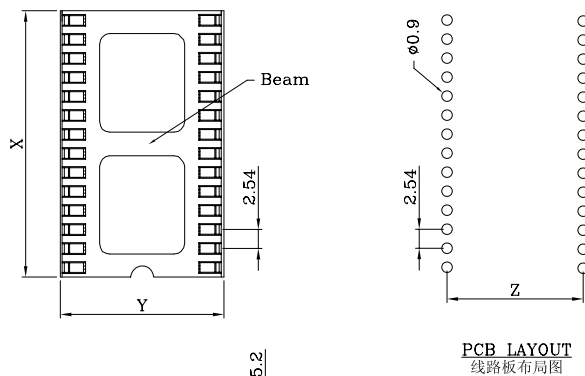

Poles 位数	Part No 产品型号	Dimensions/尺寸				
		X	Y	Z		
6	ICS-06PA-7.62	7.62	9.9	7.62		
8	ICS-08PA-7.62	10.16				
14	ICS-14PA-7.62	17.78				
16	ICS-16PA-7.62	20.32				
18	ICS-18PA-7.62	22.86				
20	ICS-20PA-7.62	25.40				
22	ICS-22PA-7.62	27.91				
24	ICS-24PA-7.62	30.48				
24	ICS-24PA-B-15.24	30.48	17.5	15.24		
28	ICS-28PA-B-15.24	35.56				
32	ICS-32PA-B-15.24	40.64				
40	ICS-40PA-B-15.24	50.80				
42	ICS-42PA-B-15.24	53.34				
48	ICS-48PA-B-15.24	60.96				
64	ICS-64PA-B-22.86	81.28			26.0	22.86

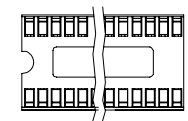

Typical 6,8,14,16,18,
20,22,24,28 Circuits

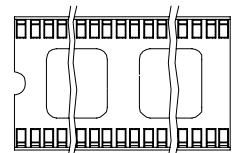

Typical 24,28,32,
40,42,48 Circuits

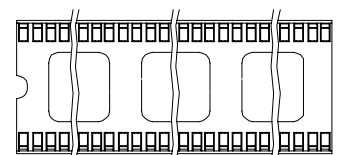

Typical 64 Circuits

Ordering Code/订购型号:

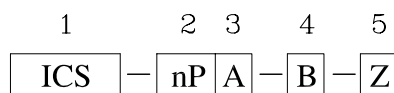

1. Series No./系列号: ICS
2. Poles/位数: See above table(看上表)
3. Pin Type/针脚类型:
 - A = Type-A
 - B = Type-B
 - C = Type-C

4. Options/选项:
 - B = With Beam(带杠)
 - N/A(缺省) = W/O Beam(无杠)
5. Linewidth/行距:
 - Z = 7.62, 15.24, 22.86.